

# KE213/6OS11-ATEX1

luminária de montagem saliente • linear



*aplicação* : indústria

*base*: alumínio lacado

*fonte de luz* : LED LP • 5000 K

*lumen operação de emergência* : 520 lm

*função*: via de evacuação/presença

*autoteste*: DALI

*segurança fotobiológica*: IEC/TR 62778: RG 0



## Medidas

*dimensões* : 423 mm x 80 mm x 135 mm

*cor*: RAL7035-cinzentos

*temperatura ambiental*: entre -20°C e 40°C •

*ATEX* : II 2D Ex tb IIIC T80°C Db, II 3G Ex ec IIC T4 Gc

## Equipamento eléctrico

*consumo de corrente* : 2.4 W

*tensão*: 220-240V

*frequência* : 50-60Hz AC

## Bateria

*funcionamento* : ajustável: não permanente/permanente

*Bateria*: 4 x NiMh 1,2V 2,1Ah

*duração* : \*60 minutos

## Luminance

*fluxo luminoso* : 520 lm

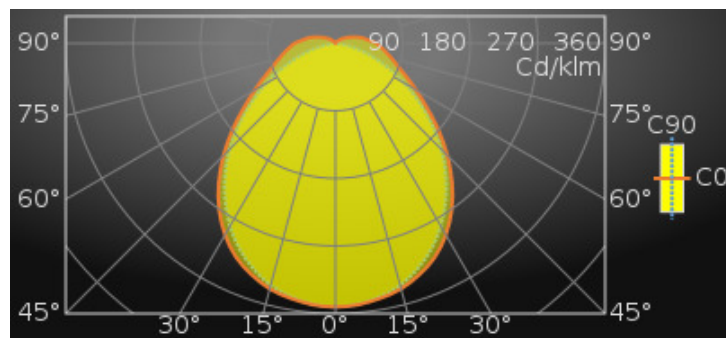

# KE213/6OS11-ATEX1

Tabelas de distância: montagem no tecto

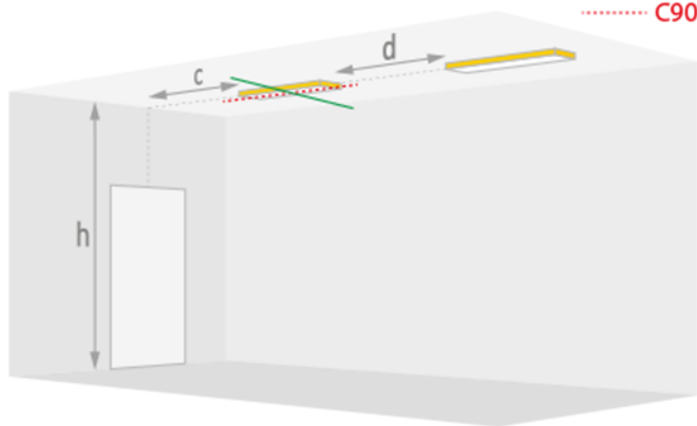
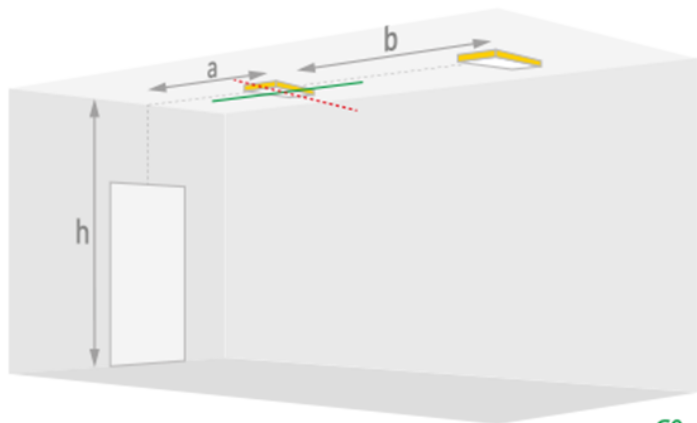

ER Ceiling for 1.0 Lux and 520 lm

H (m)	a	b	c	d
2.6	4.7	11.8	4.5	10.8
2.8	4.9	12.1	4.6	11.2
3.0	5.0	12.4	4.8	11.6
3.5	5.3	13.2	5.1	12.5
4.0	5.5	13.9	5.4	13.3
4.5	5.7	14.5	5.6	14.0
5.0	5.9	15.0	5.8	14.6
6.0	6.2	16.0	6.0	15.6
7.0	6.3	16.7	6.1	16.4
8.0	6.3	17.3	6.1	16.9
10.0	5.9	17.9	5.6	17.4
12.0	4.6	17.6	4.3	17.0

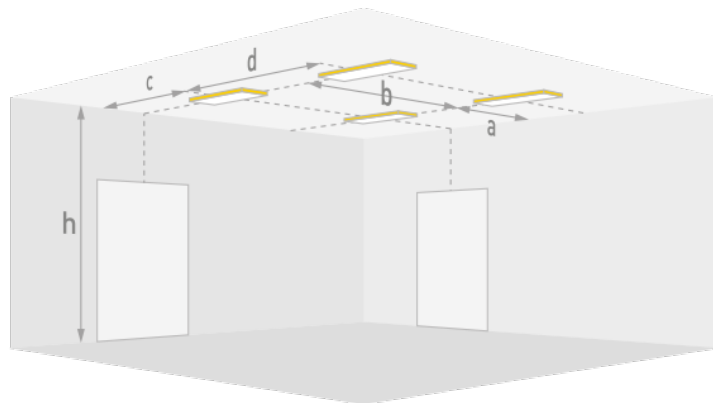

AP Ceiling for 0.5 Lux and 520 lm

H (m)	a	b	c	d
2.6	4.8	14.1	2.3	10.3
2.8	4.7	14.2	2.6	11.0
3.0	4.8	14.5	2.8	11.4
3.5	5.2	15.4	3.0	12.2
4.0	5.4	16.2	3.2	13.0
4.5	5.6	16.8	3.5	13.9
5.0	5.8	17.5	3.6	14.6
6.0	6.3	19.0	3.7	15.6
7.0	6.3	19.7	4.3	17.2
8.0	6.3	20.4	4.8	18.6
10.0	6.8	22.6	4.4	19.8
12.0	6.9	24.2	4.0	21.1

AP Ceiling for 1.0 Lux and 520 lm

H (m)	a	b	c	d
2.6	3.9	11.3	1.9	8.6
2.8	3.8	11.3	2.3	9.2
3.0	3.8	11.5	2.5	9.6
3.5	4.2	12.5	2.4	10.0
4.0	4.4	13.1	2.6	10.7
4.5	4.4	13.5	2.9	11.6
5.0	4.7	14.2	2.8	11.9
6.0	4.9	15.2	2.9	12.9
7.0	5.0	16.1	2.9	13.7
8.0	4.9	16.7	3.0	14.6

ETAP redigiu o presente documento com o maior cuidado. No entanto, as informações contidas nesta publicação são de caráter informativo e podem sofrer alterações em função da evolução técnica. ETAP não se responsabiliza por danos de qualquer espécie, resultantes da utilização deste documento. [www.etaplighting.com](http://www.etaplighting.com) // Made in Belgium

# KE213/6OS11-ATEX1

## Distance tables: wall mounted

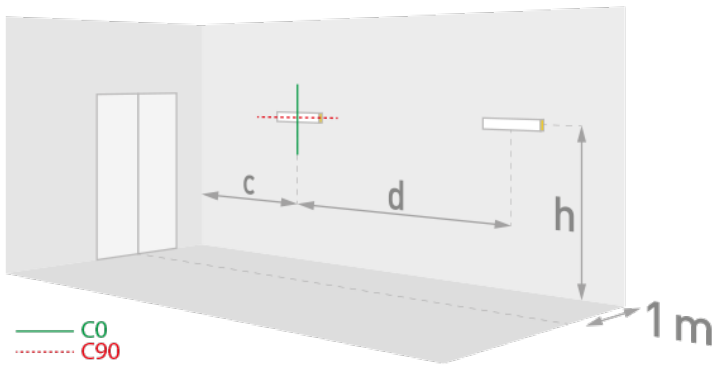
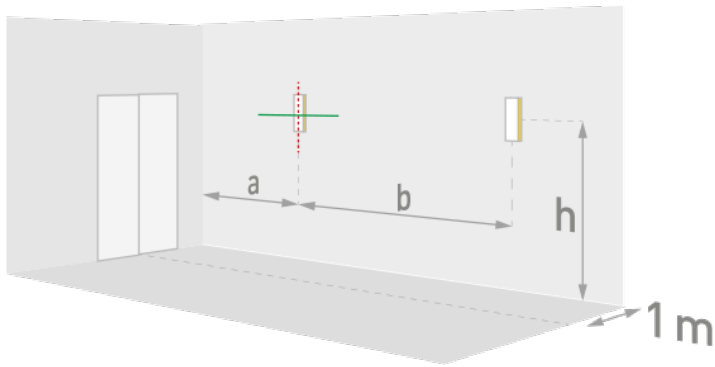

— C0  
- - - C90

AP Wall for 0.5 Lux and 520 lm

H (m)	a	b	c	d
1.4	4.1	10.6	3.1	7.4
1.6	4.2	11.0	3.2	7.7
1.8	4.3	11.3	3.3	8.1
2.0	4.4	11.6	3.4	8.3
2.2	4.4	11.8	3.5	8.6
2.4	4.4	11.9	3.5	8.9
2.6	4.4	12.1	3.6	9.1
2.8	4.4	12.2	3.6	9.3
3.0	4.4	12.2	3.7	9.5
3.5	---	8.8	3.8	9.8
4.0	---	---	3.8	10.1
4.5	---	---	3.7	10.3
5.0	---	---	3.6	10.4
6.0	---	---	3.2	10.4
7.0	---	---	2.5	10.0
8.0	---	---	1.2	9.2
10.0	---	---	---	4.4

ER Wall for 1.0 Lux and 520 lm

H (m)	a	b	c	d
1.4	3.3	8.6	2.9	7.1
1.6	3.4	8.8	3.0	7.3
1.8	3.4	9.0	3.0	7.5
2.0	3.4	9.2	3.1	7.7
2.2	3.4	9.3	3.1	7.8
2.4	3.4	9.3	3.1	8.0
2.6	3.3	9.4	3.1	8.1
2.8	3.3	9.4	3.1	8.1
3.0	3.2	9.3	3.0	8.2
3.5	2.8	8.6	2.9	8.3
4.0	---	---	2.8	8.2
4.5	---	---	2.5	8.1
5.0	---	---	2.1	7.8
6.0	---	---	0.8	7.0
7.0	---	---	---	4.4
8.0	---	---	0.1	0.6

AP Wall for 1.0 Lux and 520 lm

H (m)	a	b	c	d
1.4	3.2	8.3	2.5	6.2
1.6	3.2	8.5	2.6	6.4
1.8	3.2	8.6	2.6	6.6
2.0	3.2	8.7	2.7	6.8
2.2	3.2	8.8	2.7	7.0
2.4	3.1	8.8	2.7	7.1
2.6	3.0	8.8	2.8	7.2
2.8	2.8	8.7	2.7	7.3
3.0	---	5.9	2.7	7.4
3.5	---	---	2.6	7.5
4.0	---	---	2.5	7.5
4.5	---	---	2.2	7.4
5.0	---	---	1.8	7.2
6.0	---	---	0.3	6.3
7.0	---	---	---	3.5

# KE213/6OS11-ATEX1

## Diagrama Isolux - montagem na parede

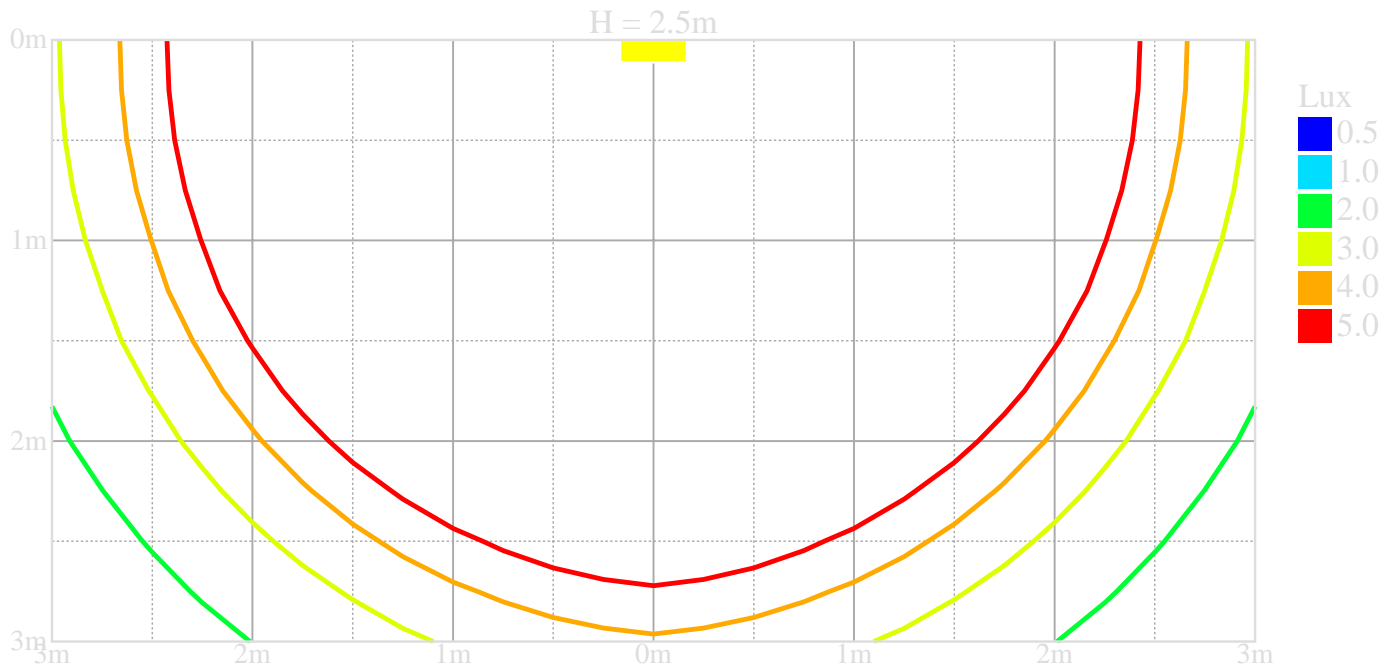

## Esboço

