

KE212/6S4-ATEX1

ytmonterad armatur • rektangulär



installation : Industri

armaturhus: lackerat aluminium

ljuskälla : low power LED • 5000 K

lumen nödläge : 550 lm

funktion: utrymningsväg/öppna ytor

självtest: Med inbyggt självtest - EST+ Med inbyggt självtest - EST+ med fjärrkontrollen

fotobiologisk säkerhet: EN 62471: RISK GROUP 0 UNLIMITED



Armaturlära

dimensioner : 423 mm x 80 mm x 135 mm

kulör: RAL7035 - grå

IP: IP66

ambient temperature: från 0°C - 40°C •

ATEX : II 2D Ex tb IIIC T80°C Db, II 3G Ex ec IIC T4 Gc

Elektrisk data

energiförbrukning : 2.4 W

spänning: 220-240V

frekvens : 50-60Hz AC

Batteri

driftläge : justerbar: ej underhållen/underhållen

Batteri: 4 x NiMh 1,2V 2,2Ah

varaktighet : *60 minuter

Luminans

ljusflöde : 550 lm

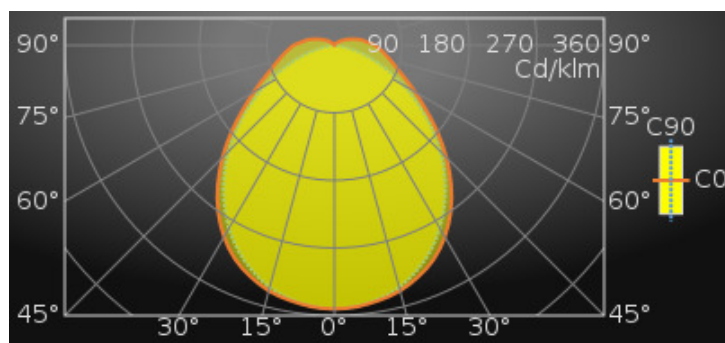

KE212/6S4-ATEX1

Avståndstabeller: takmontage

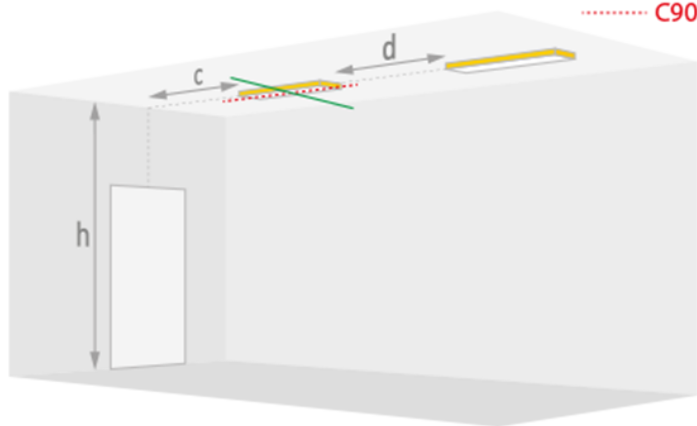
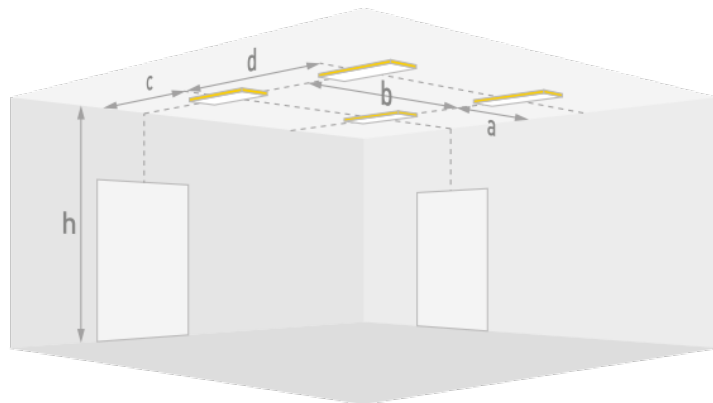
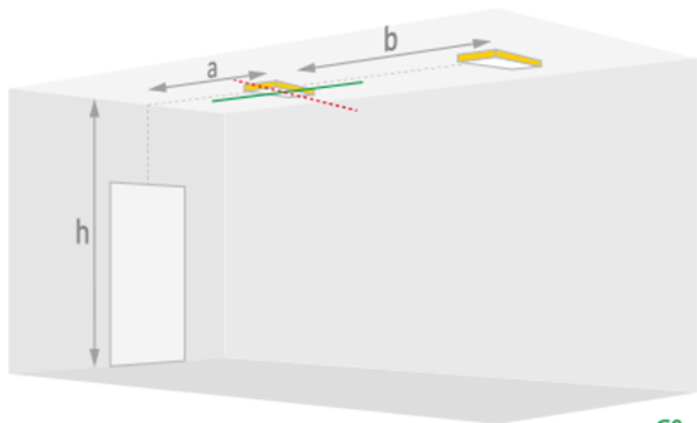

ER Ceiling for 1.0 Lux and 550 lm

H (m)	a	b	c	d
2.6	4.8	12.0	4.6	11.0
2.8	5.0	12.3	4.7	11.4
3.0	5.1	12.7	4.9	11.8
3.5	5.4	13.4	5.2	12.7
4.0	5.6	14.1	5.5	13.5
4.5	5.9	14.7	5.7	14.2
5.0	6.1	15.3	5.9	14.8
6.0	6.3	16.3	6.2	15.9
7.0	6.5	17.1	6.3	16.7
8.0	6.5	17.7	6.3	17.3
10.0	6.1	18.3	5.9	17.9
12.0	5.0	18.2	4.7	17.6

AP Ceiling for 0.5 Lux and 550 lm

H (m)	a	b	c	d
2.6	4.8	14.2	2.4	10.6
2.8	4.9	14.6	2.5	11.0
3.0	5.0	14.9	2.7	11.4
3.5	5.4	15.8	2.9	12.2
4.0	5.5	16.4	3.3	13.3
4.5	5.9	17.4	3.2	13.8
5.0	6.2	18.2	3.3	14.4
6.0	6.4	19.2	3.9	16.0
7.0	6.5	20.2	4.2	17.4
8.0	7.0	21.6	4.0	18.0
10.0	7.0	23.0	4.6	20.1
12.0	6.7	24.2	4.7	22.0

AP Ceiling for 1.0 Lux and 550 lm

H (m)	a	b	c	d
2.6	4.2	11.8	1.6	8.3
2.8	3.9	11.6	2.3	9.2
3.0	4.0	12.0	2.2	9.5
3.5	4.2	12.5	2.6	10.4
4.0	4.4	13.2	2.7	11.0
4.5	4.6	13.9	2.8	11.5
5.0	4.7	14.4	2.9	12.2
6.0	4.7	15.2	3.3	13.5
7.0	4.9	16.2	3.2	14.2
8.0	5.0	17.0	3.1	14.9

Detta dokument har sammanställts av ETAP med största noggrannhet. Uppgifterna i denna publikation är dock inte bindande och kan ändras på grund av teknisk utveckling. ETAP är inte ansvarskyldigt för skada, av vilket slag det vara må, till följd av användningen av detta dokument. www.etaplighting.com // Made in Belgium

KE212/6S4-ATEX1

Distance tables: wall mounted

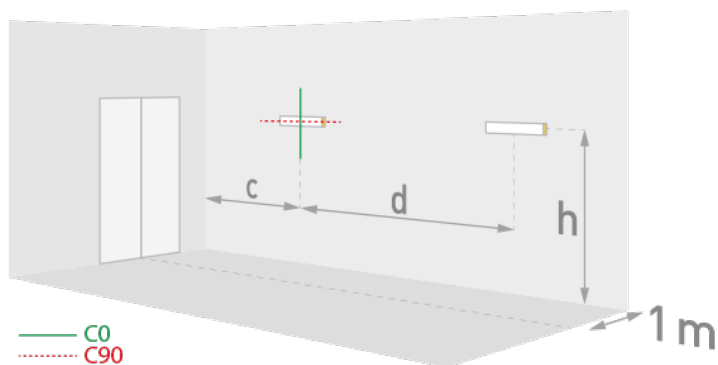
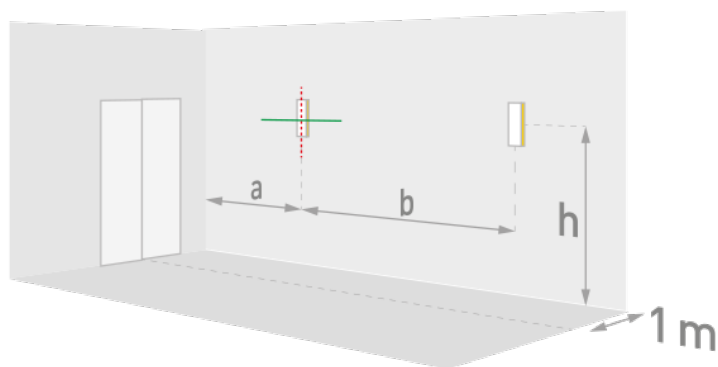

ER Wall for 1.0 Lux and 550 lm

H (m)	a	b	c	d
1.4	3.4	8.8	2.9	7.2
1.6	3.5	9.0	3.0	7.5
1.8	3.5	9.2	3.1	7.7
2.0	3.5	9.4	3.1	7.8
2.2	3.5	9.5	3.1	8.0
2.4	3.5	9.6	3.2	8.1
2.6	3.5	9.6	3.2	8.2
2.8	3.4	9.6	3.1	8.3
3.0	3.3	9.6	3.1	8.4
3.5	2.9	9.3	3.0	8.5
4.0	---	---	2.9	8.4
4.5	---	---	2.6	8.3
5.0	---	---	2.3	8.1
6.0	---	---	1.2	7.3
7.0	---	---	---	5.0
8.0	---	---	---	2.0

AP Wall for 0.5 Lux and 550 lm

H (m)	a	b	c	d
1.4	4.2	10.9	3.1	7.5
1.6	4.3	11.2	3.2	7.9
1.8	4.4	11.5	3.3	8.2
2.0	4.5	11.8	3.4	8.5
2.2	4.5	12.0	3.5	8.7
2.4	4.6	12.2	3.6	9.0
2.6	4.6	12.4	3.7	9.2
2.8	4.5	12.5	3.7	9.4
3.0	4.5	12.6	3.8	9.6
3.5	---	9.8	3.8	10.0
4.0	---	---	3.9	10.3
4.5	---	---	3.8	10.6
5.0	---	---	3.7	10.7
6.0	---	---	3.4	10.7
7.0	---	---	2.7	10.4
8.0	---	---	1.6	9.7
10.0	---	---	---	5.2

AP Wall for 1.0 Lux and 550 lm

H (m)	a	b	c	d
1.4	3.2	8.4	2.6	6.3
1.6	3.3	8.7	2.6	6.5
1.8	3.3	8.8	2.7	6.7
2.0	3.3	8.9	2.7	6.9
2.2	3.3	9.0	2.8	7.1
2.4	3.2	9.1	2.8	7.3
2.6	3.1	9.1	2.8	7.4
2.8	3.0	9.0	2.8	7.5
3.0	---	6.5	2.8	7.6
3.5	---	---	2.7	7.7
4.0	---	---	2.6	7.7
4.5	---	---	2.3	7.7
5.0	---	---	2.0	7.5
6.0	---	---	0.7	6.7
7.0	---	---	---	4.1
8.0	---	---	---	0.1

KE212/6S4-ATEX1

Isolux diagram - väggmontering

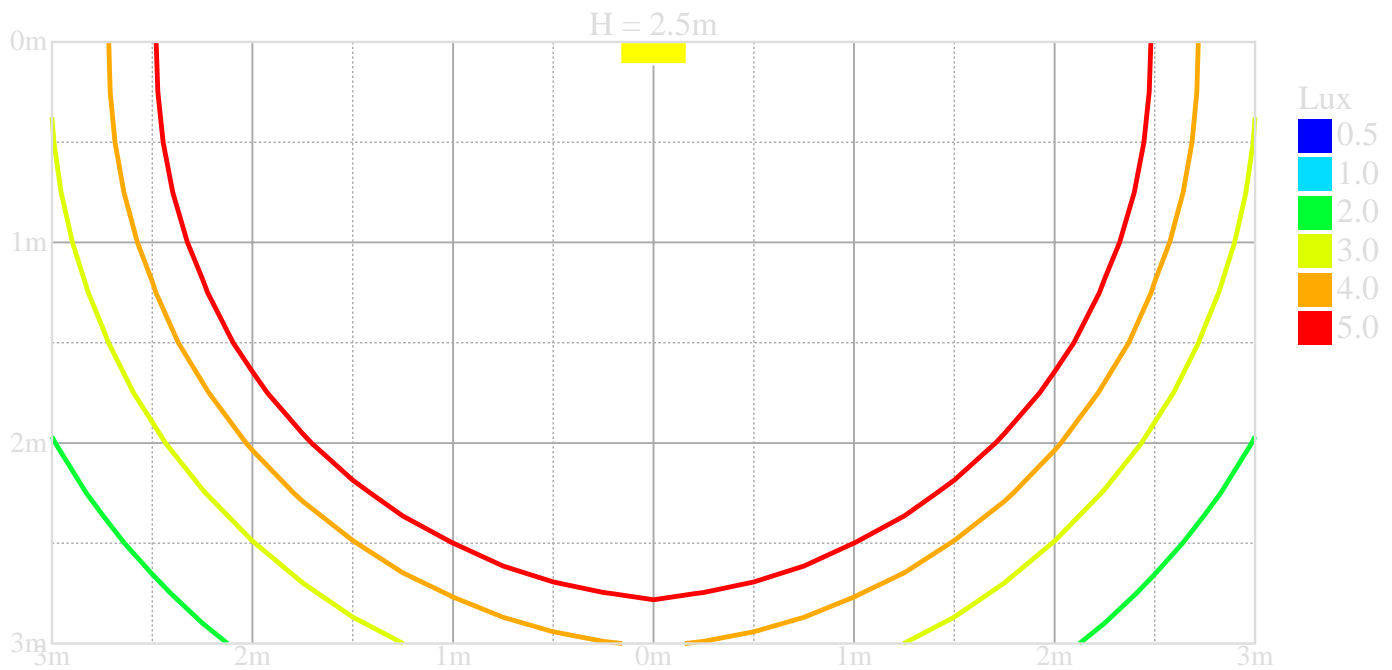

Måttskiss

